

KUBICA K5080

A new invisible hinge:

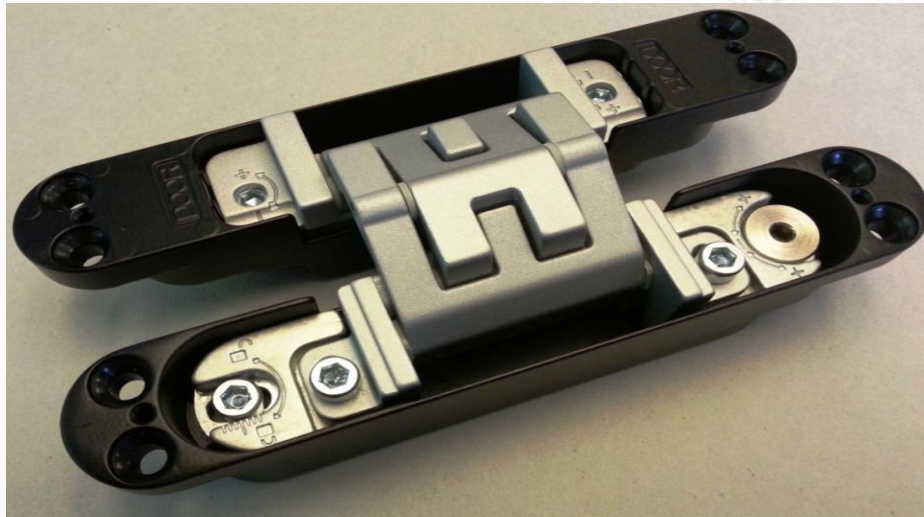

- 5 rotation pivots
- 80 kg capacity



K5080 – technical specifications

Material: Zama

Available finishing: satin chrome, satin nickel

Tested for doors: 600/900 x 2100 mm

Min panel thickness: **40 mm**

Version: reversible

Capacity: **80 kg** with 2 hinges

Accessories: fixing plate for wooden jamb

K5080 – technical specifications

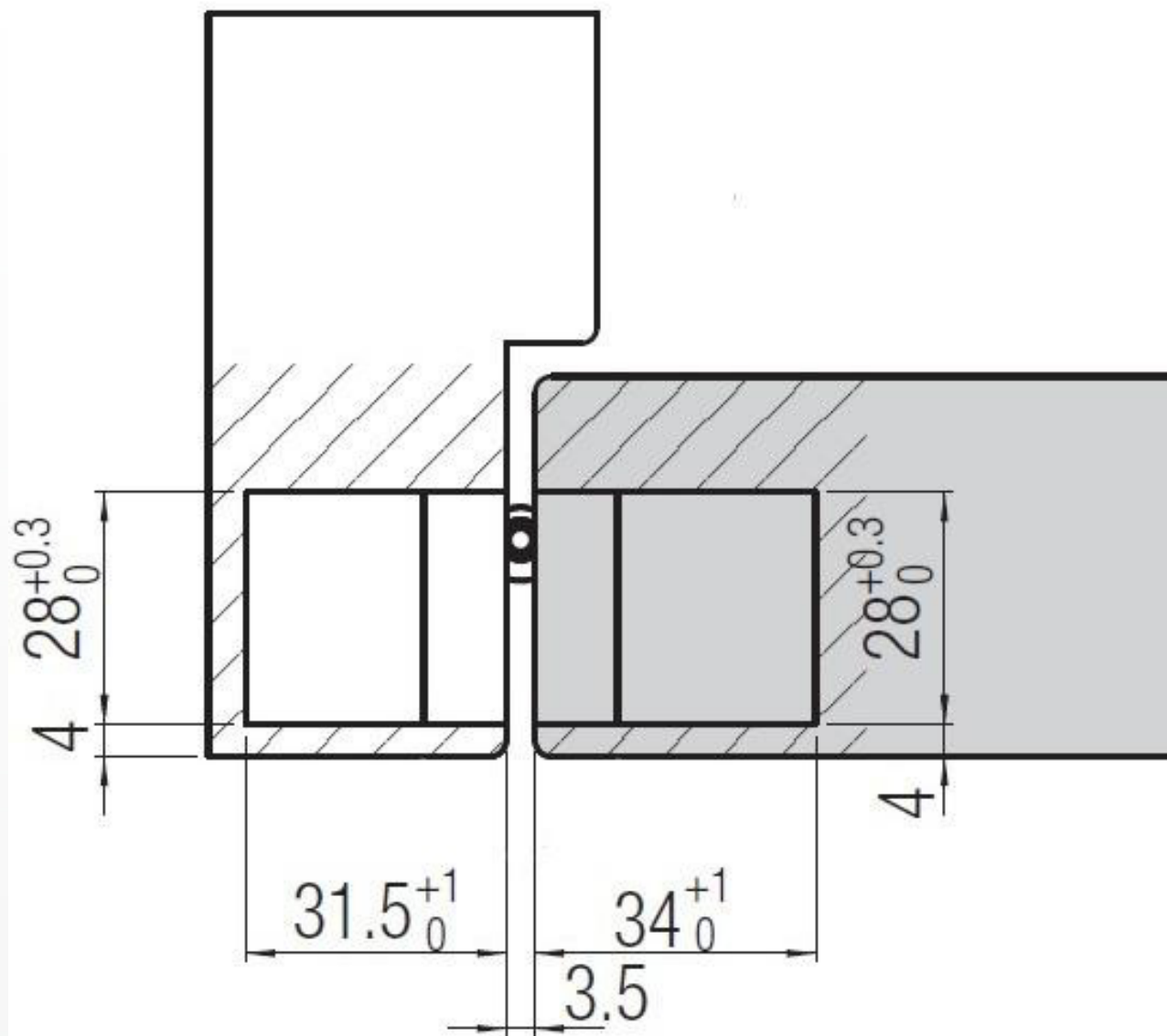

K5080 – technical specifications

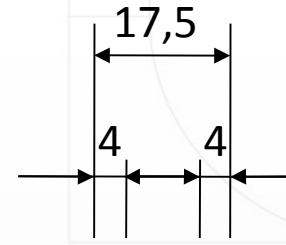
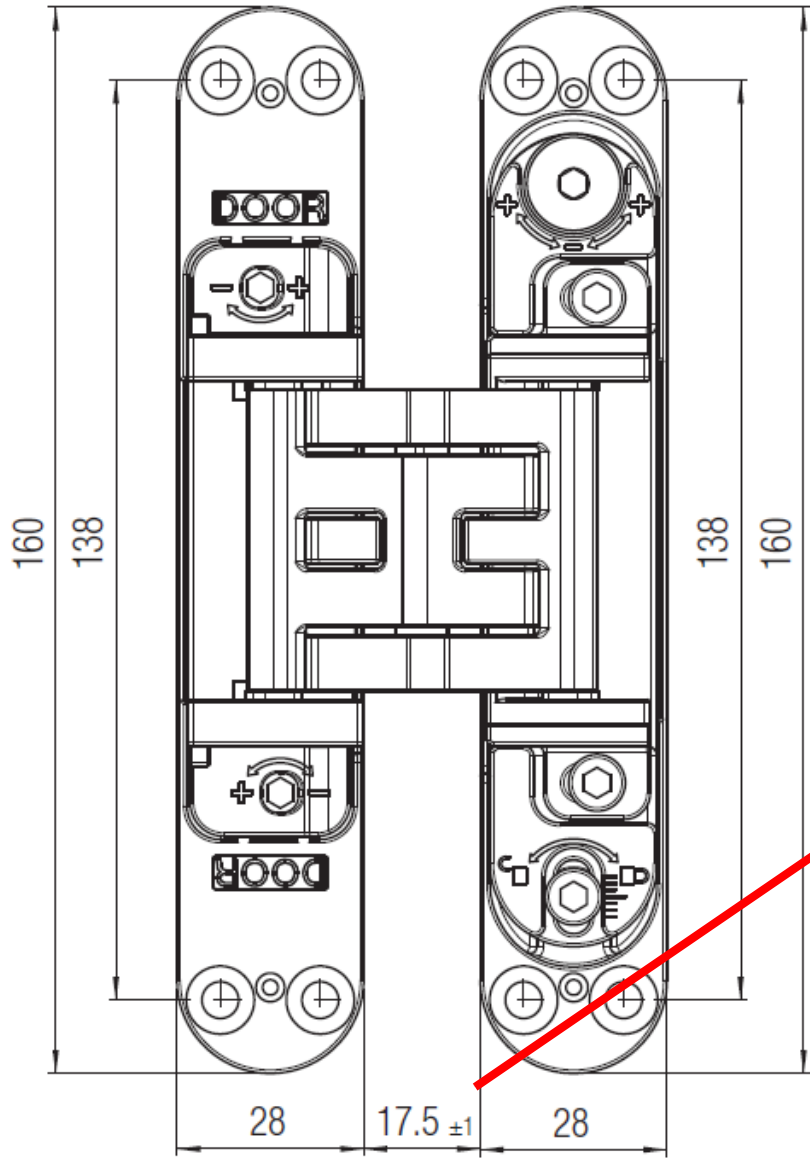

9,5 mm

Greater gap of 2 mm compared to K7080 = 7,3 mm
K7080

- K2700 = 13,75 mm
- K3000 = 16,8 mm
- K6300 = 17,5 mm



K5080 – technical specifications

KOBLENZ

More gap of 2,2 mm helps to avoid the contact between door and jamb.

This situation is mainly possible when only 2 hinges are installed.

Suitable for rough edges (if spoking is not applied)





K5080 – adjustment

Allen key no.4

KRONA KOBLENZ

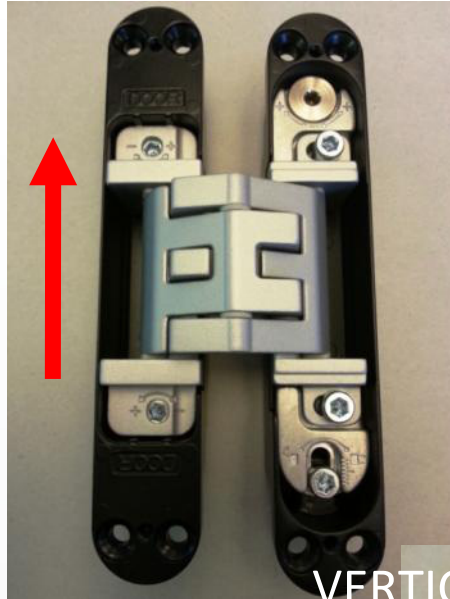
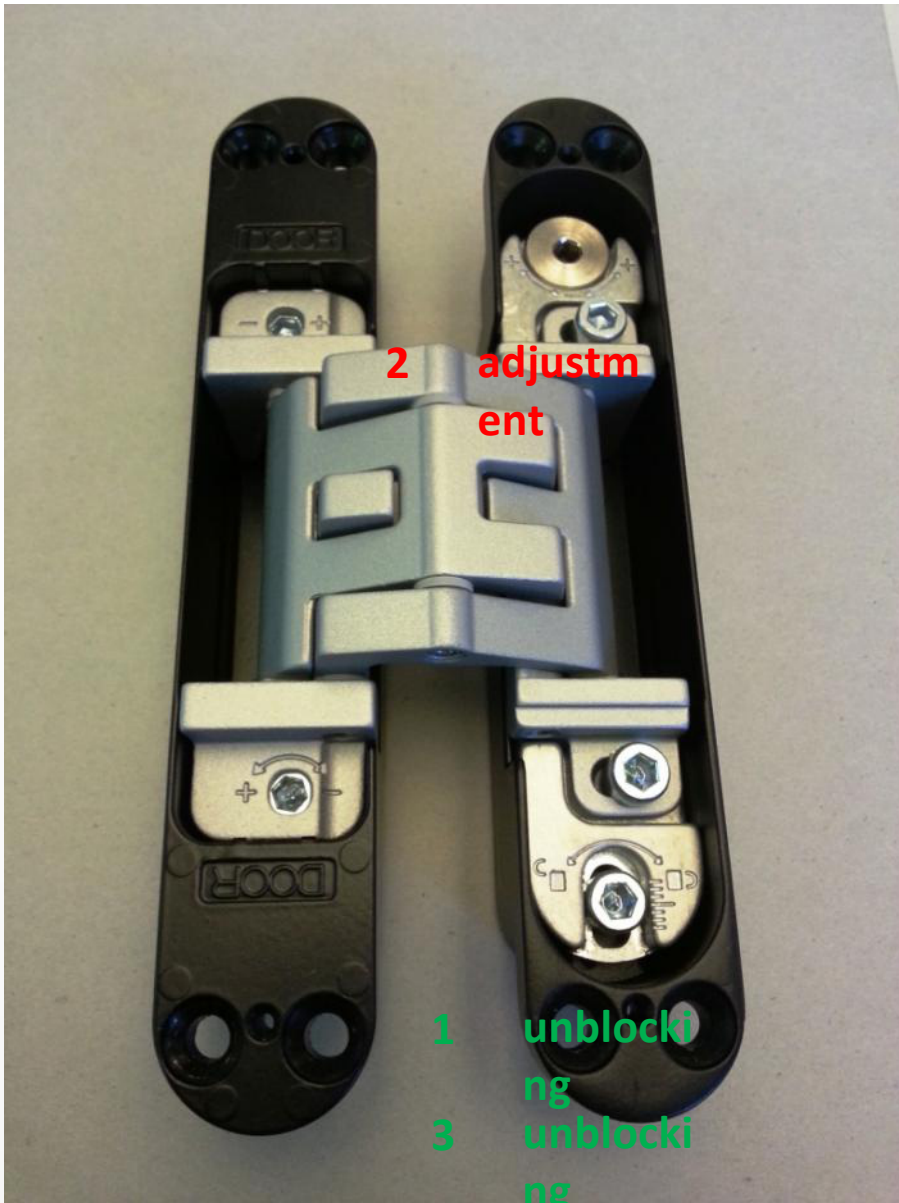

VERTICAL

±3mm

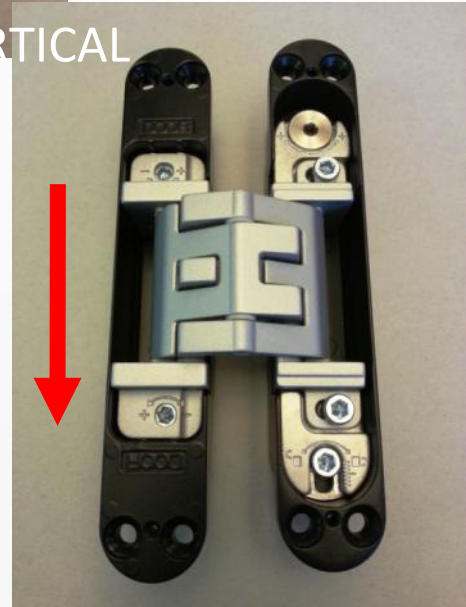



K5080 – adjustment

Allen key no.4

KRONA KOBLENZ

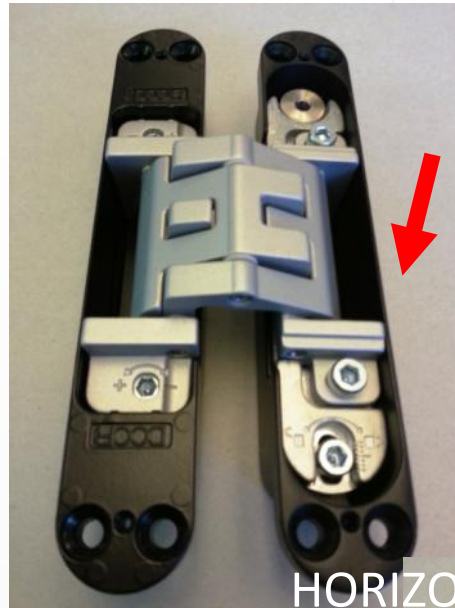
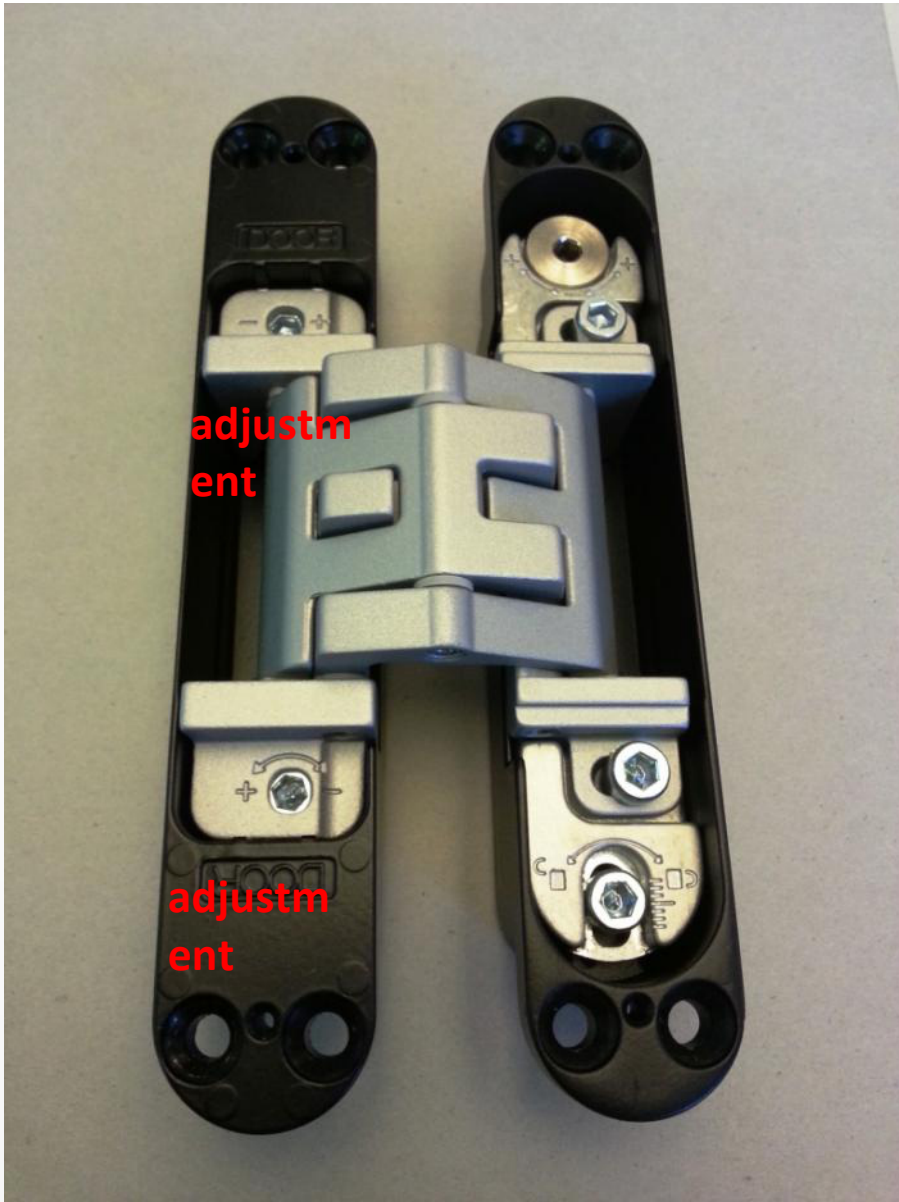

±3mm

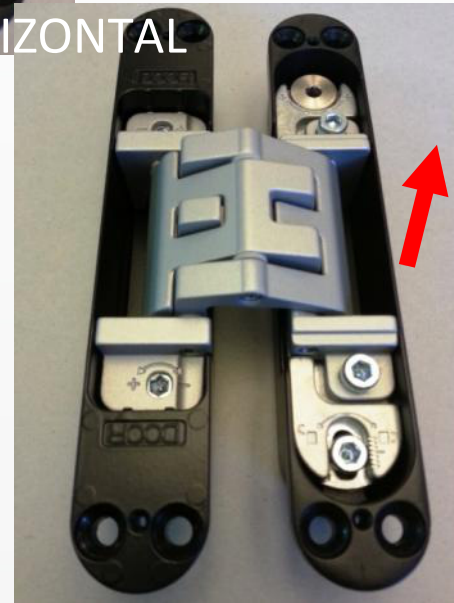



K5080 – adjustment

Allen key no.4

KRONA KOBLENZ

2 adjustment

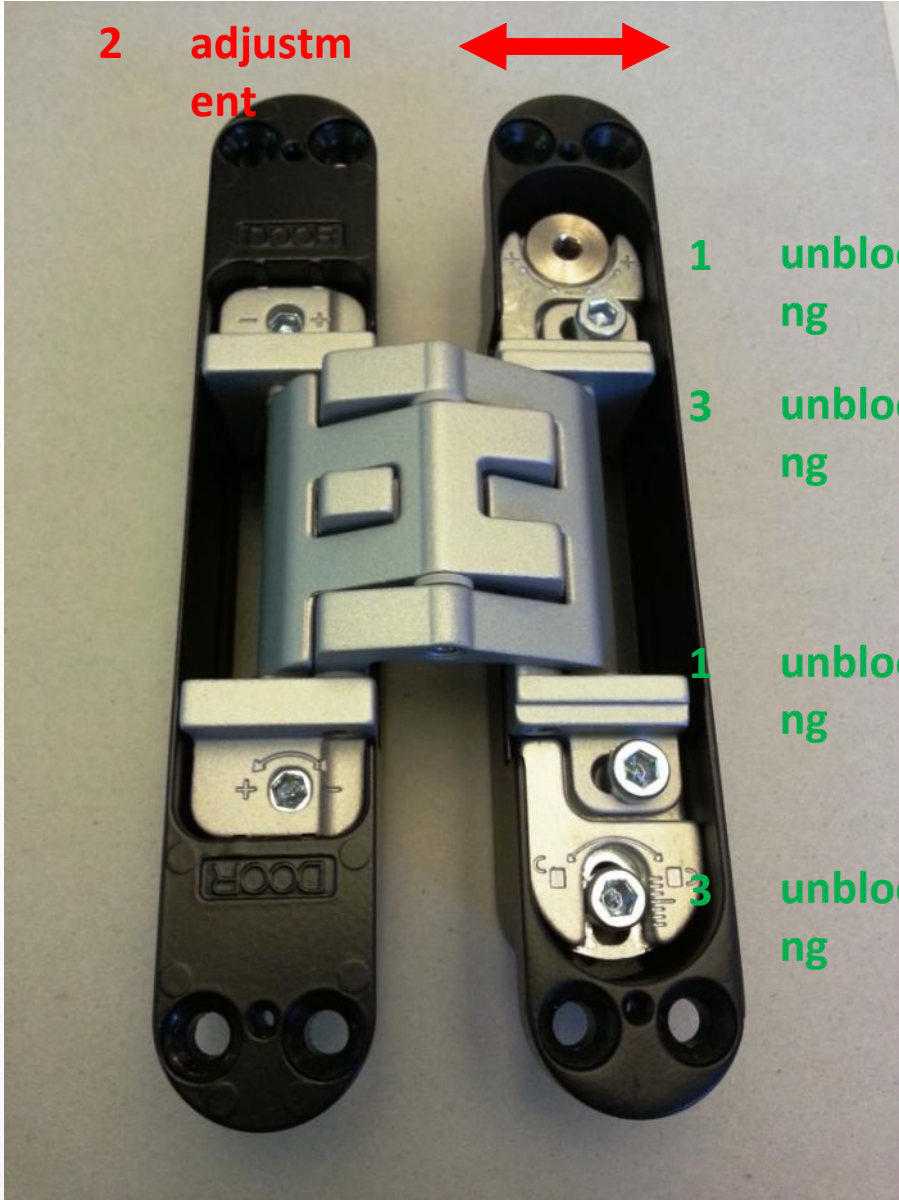
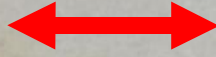

1 unblocking

3 unblocking

1 unblocking

3 unblocking

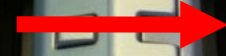
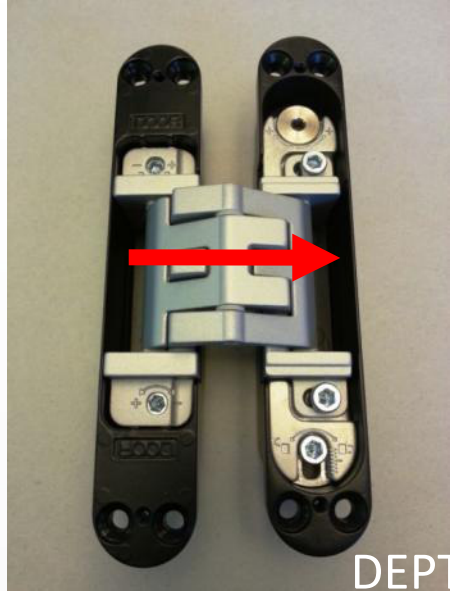

DEPTH

±1mm

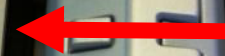
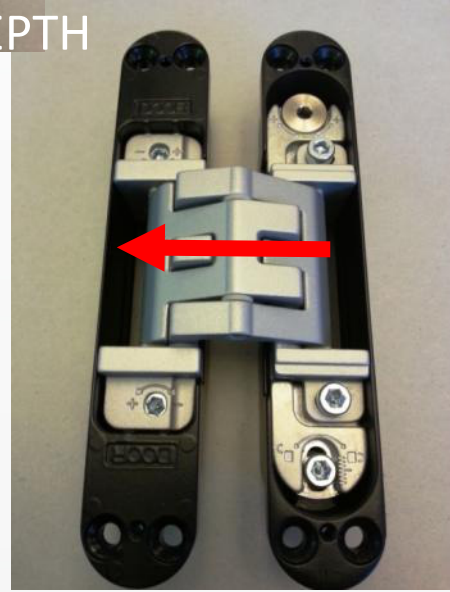

K5080 – COVER FINISHING

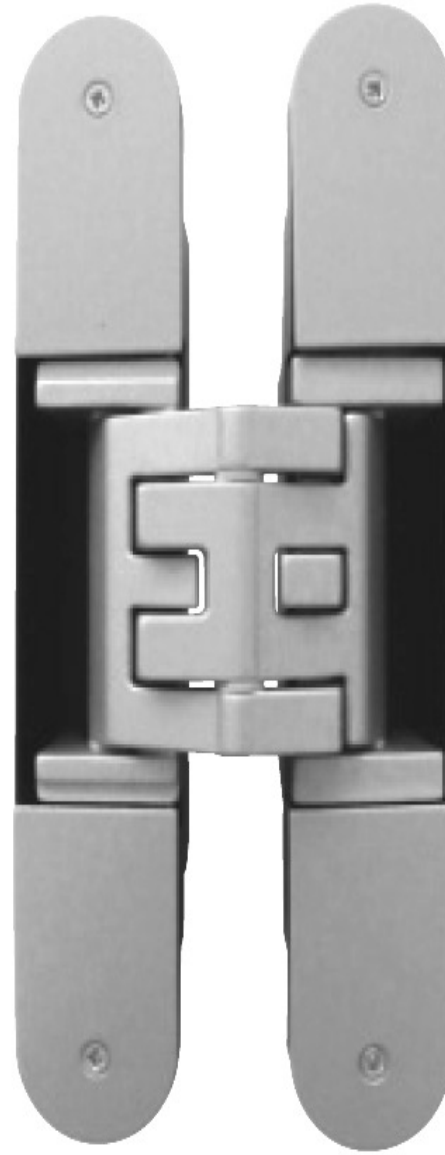
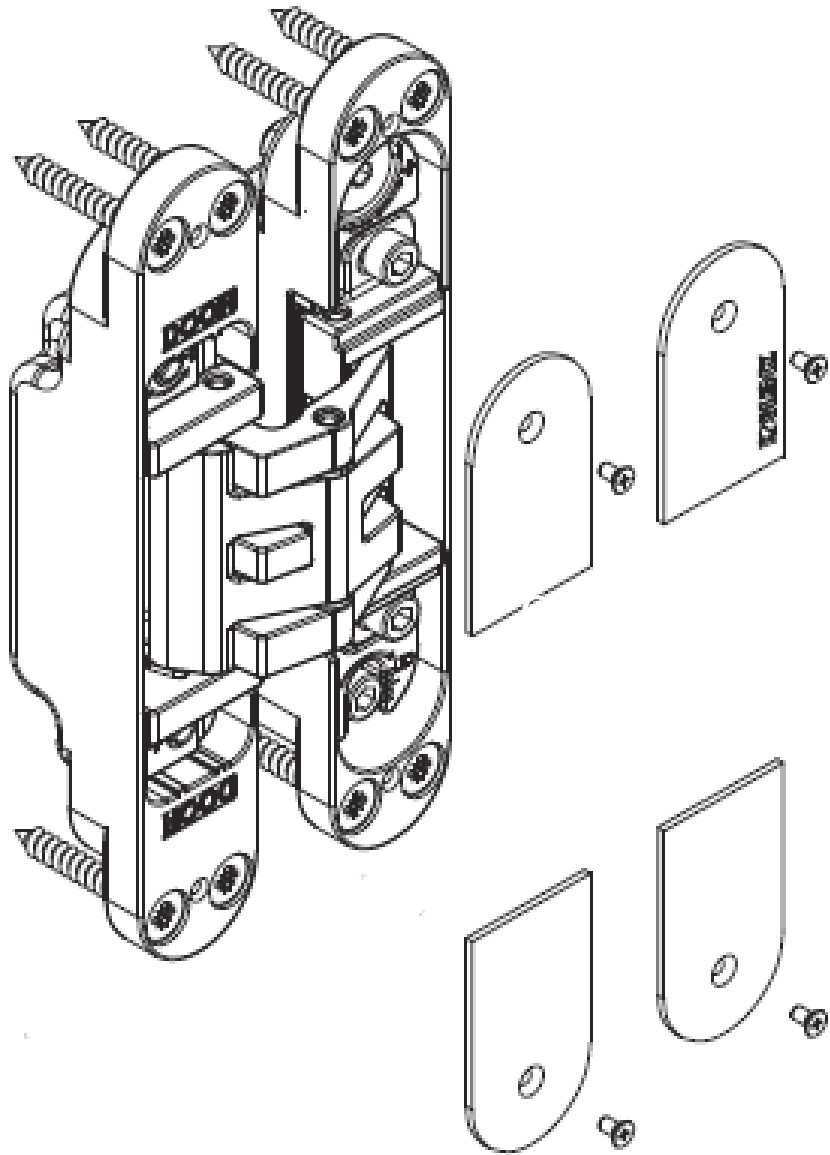

K5080 – COVER FINISHING



The relative hole for the fixing screw of the cover IS NOT threaded

The screw is self-threading while entering its zama base